

LCD&LCM SPECIFICATION

液晶显示屏产品使用说明书

MODULE NO.

————12864-61B————

128x64 图形点阵

COG 工艺

Designed	Checked	Approved

Revision history 修改记录

revision	date	description	remark
A00	2013-10-08	First release	



深圳市科飞研科技有限公司

深圳市科飞研科技有限公司

Content/目录

1. **Feature/显示特性**
2. **Mechanical specifications/外形尺寸说明**
3. **Block diagram & power supply/电路原理图**
4. **Pin description/PIN 脚描述**
5. **Absolute maximum rating/限定参数**
6. **Electrical characteristics/电气特性**
7. **Backlight characteristics/背光特性**
8. **Electrical-optical characteristics/光学特性**
9. **Control and display commands/指令描述**
10. **DDRAM 映射表**
11. **Inspection standards/检验标准**
12. **Handling precautions/注意事项**

1. Feature/显示特性

Display resolution/点阵数	: 128(w)*64(h)
Display mode/显示模式	: STN ,Positive, Green-Yellow Transflective
Driving method/驱动方式	: 1/64 Duty , 1/9 Bias
Viewing direction/视角	: 6:00 o'clock
Backlight/背光	: LED , White(or Green,Blue,Other)
Built-in controller/控制器	: ST7565R
Operation temp/工作温度	: -20℃~70℃
Storage temp/储存温度	: -30℃~80℃

2. Mechanical Specifications/外形尺寸说明

2.1 尺寸描述

Dimensional outline (W*H*T)/外形尺寸 : 82.6mm*49.0mm*5.5mm (含背光)
78 mm*49.0mm* 2.8mm (不含背光)

Viewing area (W*H)/视域尺寸 : 71.7mm*38.8mm

Dot pitch (W*H)/点距 : 0.52mm*0.52mm

Dot size (W*H)/点大小 : 0.48mm*0.48mm

2.2 Outline Dimension 外形尺寸图

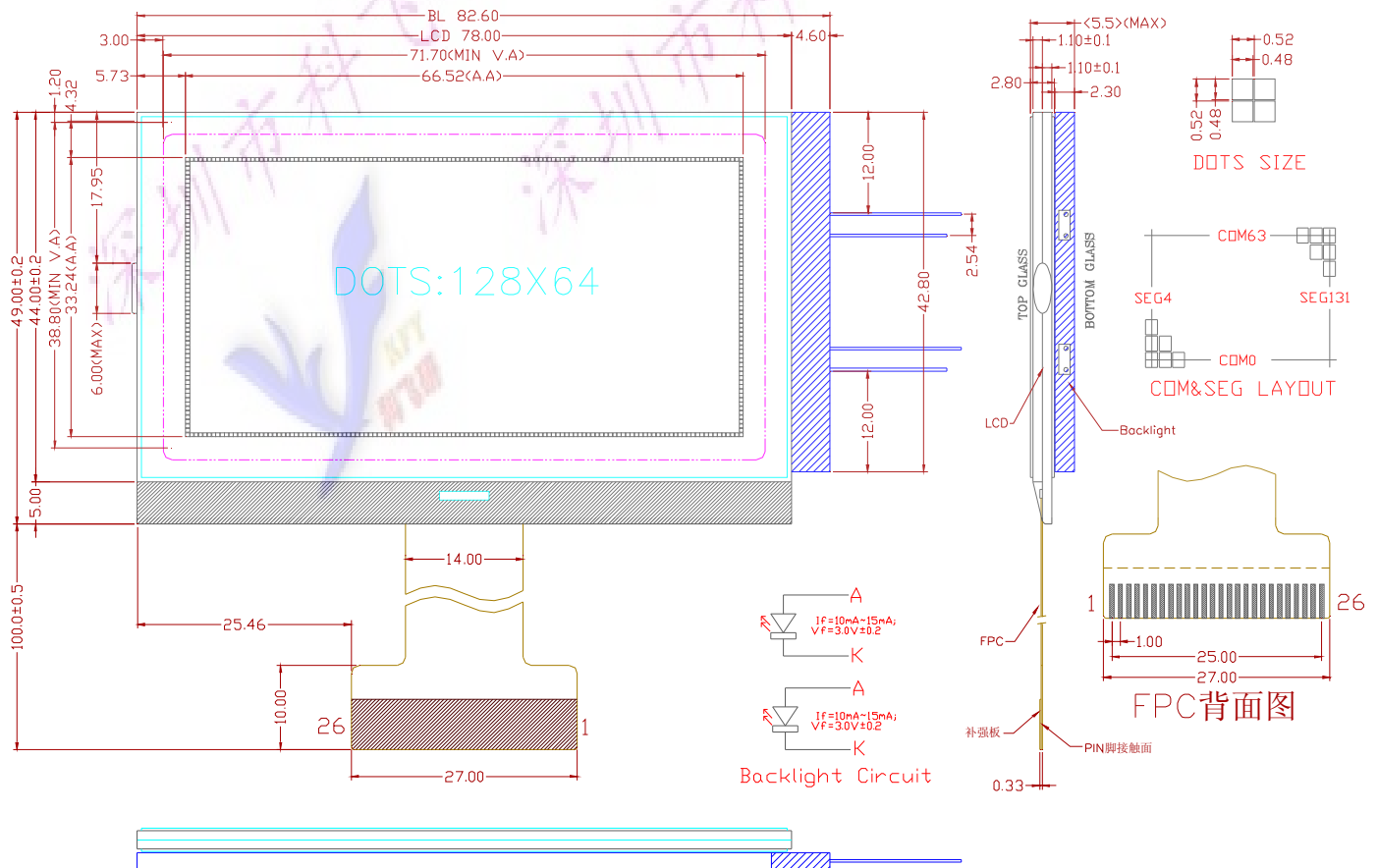

3.Block Diagram & Power supply/电路原理图

外围电路参考

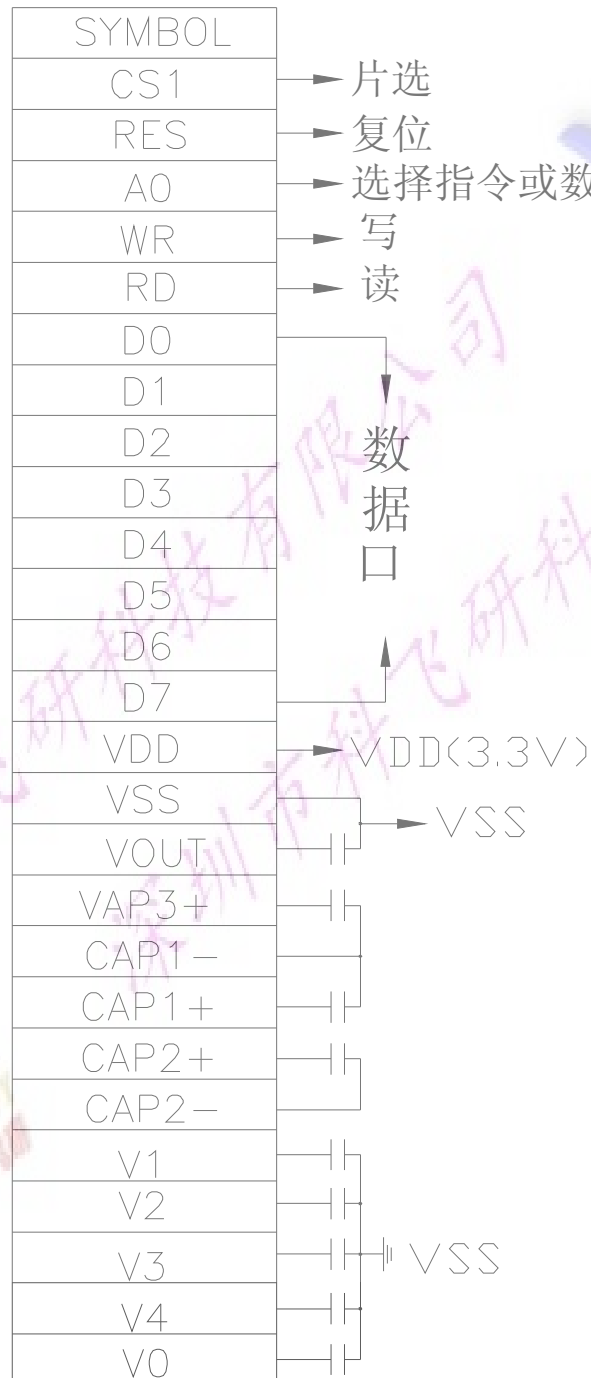

全部采用1uF/25V 无极性电容

4. Pin description/PIN 脚描述

Pin No.	Pin Name	Function
1	CS1	Chip selection input 片选
2	RES	Rester 复位
3	A0	Data/Command control 选择指令或数据
4	WR	Write (/WR) control signal input. 写
5	RD	Read (/RD) control signal input. 读
6~13	D0---D7	8bit Date bus 数据
14	VDD	Power supply voltage (Positive) 电源 3~3.3V
15	VSS	Negative power supply,0V 地
16	VOUT	positive voltage supply pin of the chip. 升压输出, 对地接电容
17~21	CAP3+, CAP1-, CAP1+, CAP2+, CAP2-	When internal DC-DC voltage converter is used, external capacitor is connected between these pins. 升压电路接电容
22~26	V1,V2,V3,V4,V0	LCD driving voltages. 分压电路

LED 背光引脚（两颗独立 LED）

A	（长的脚）LED 正极，供电电压+3.0V，单颗灯的工作电流 10mA~15mA，如用 IO 口控制，需加三极管开关放大电路。
K	（短脚）LED 负极，0V，或接 VSS。

6.2.2 Reset timing

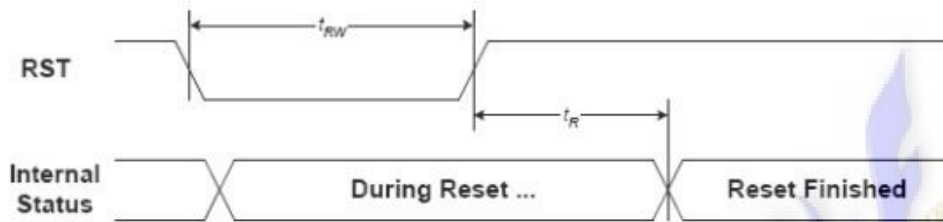

FIGURE 15: Reset Characteristics

($1.65V \leq V_{DD} < 3.3V$, $T_a = -30$ to $+85^\circ C$)

Symbol	Signal	Description	Condition	Min.	Max.	Units
t_{RW}	RST	Reset low pulse width		3	—	μS
t_R	RST,, Internal Status	Reset to Internal Status pulse delay		6	—	mS

7. Backlight Characteristics/背光特性

Items	Symbol	MIN.	TYP.	MAX.	Unit	Condition
Forward Voltage/电压	V_f	2.8	3.0	3.1	V	$I_f=30mA$
Reverse current/电流	I_r	---	20	30	mA	$V_r=3V$
Peak wave length/波长	λ	---	---	---	nM	$I_f=25mA$
Luminance/亮度	L_v	---	---	---	Cd/m^2	$I_f=25mA$
Color /颜色	White (白色, 或者其他色)					

8. Electrical-Optical Characteristics/光学特性

Items	Symbol	Condition	MIN.	TYP.	MAX.	Unit	NOTE
Response time/反应时间	T_r	$T_a = 25^\circ C$	---	185	---	ms	2
	T_f		---	200	---		
Contrast ratio/对比度	Cr	$T_a = 25^\circ C$	---	--	---	degree	3
Viewing angle range/视角范围	θ	$Cr \geq 2$	-40	---	40		

Note 1. Definition of response time

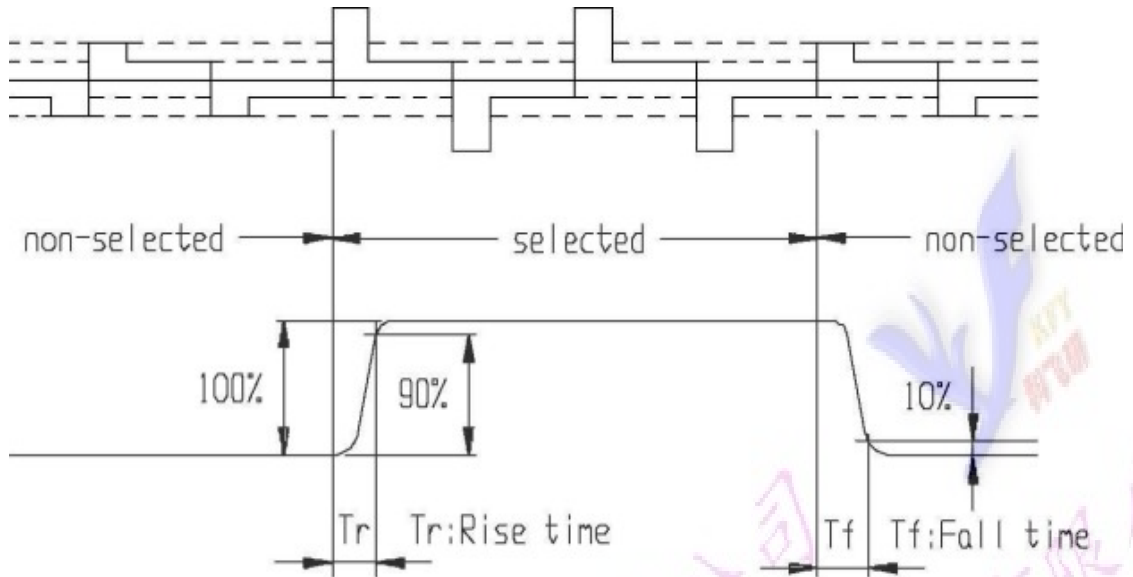

Note2 . Definition of Contrast Ratio 'Cr'

Note 3. Definition of Viewing Angle Range 'θ'

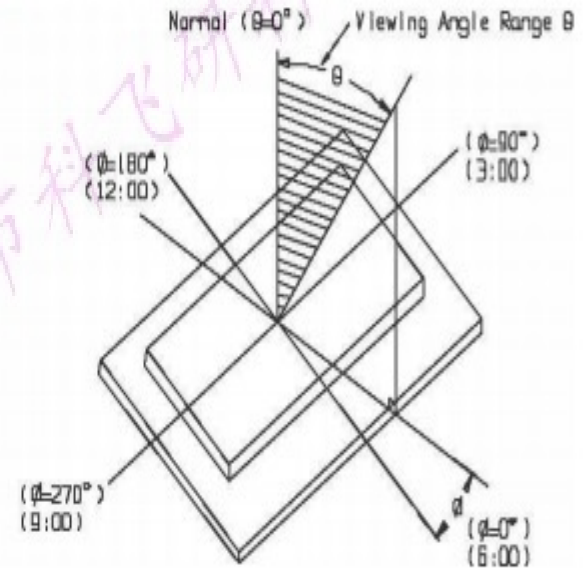
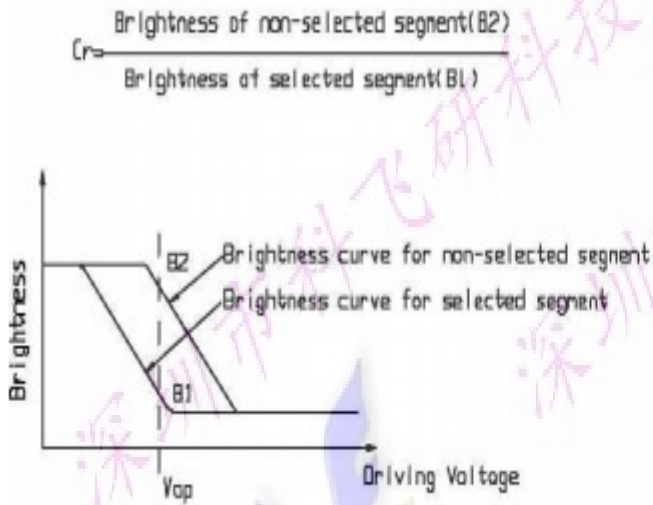

9. Control and display commands/指令描述

No.	Instrctions	Code												Function
		A0	/RD	/WR	D7	D6	D5	D4	D3	D2	D1	D0		
1	Display ON/OFF	0	1	0	1	0	1	0	1	1	1	1	DON	DON=0,display off DON=1,display on
2	Display start line set	0	1	0	0	1	Display start address						Set the display RAM display start line address	
3	Set Page Address	0	1	0	1	0	1	1	Page address					Set the display RAM Page address
4	Ser Column Address (Upper-4 bits)	0	1	0	0	0	0	1	Col. Add					Set the upper-4-bit of column address counter
	Ser Column Address (Lower-4 bits)	0	1	0	0	0	0	0	Col. Add					Set the low-4-bit of column address counter
5	Read Staus	0	0	1	Status				0	0	0	0	0	Read the status data
6	Write Display Data	1	1	0	Write Data								Write data into the display RAM	
7	Read Display Data	1	0	1	Read Data								Read data from the display RAM	
8	ADC Select	0	1	0	1	0	1	0	0	0	0	0	ADC	Set the display RAM address SEG output Correspondence ADC = 0,Normal. ADC = 1,Reverse
9	Normal/Reverse Display	0	1	0	1	0	1	0	0	1	1	REV	REV = 0, Normal REV = 1, Reverse	
10	Entire Display ON/OFF	0	1	0	1	0	1	0	0	1	0	EON	EON = 0, Normal EON = 1, Entire display ON	
11	Set LCD Bias	0	1	0	1	0	1	0	0	0	1	BIAS	Bias = 0, 1/9 Bias Bias = 1, 1/7 Bias	
12	Set Read-Modify-Write	0	1	0	1	1	1	0	0	0	0	0	Enter the "Read-Modify-Write" mode	
13	Reset Read-Modify-Write	0	1	0	1	1	1	0	1	1	1	0	Clear the "Read-Modify-Write" mode	
14	Reset	0	1	0	1	1	1	0	0	0	1	0	Resets the LCD module	
15	SHL S elect	0	1	0	1	1	0	0	SHL	*	*	*	Set the COM scanning direction SHL = 0, Normal SHL = 1, Flipped in y-direction * = don't care terms	
16	Power Control Set	0	1	0	0	0	1	0	1	VC	VR	VF	Set the power circuit operation mode VF : LCD Supply Voltage Follower VR : LCD Supply Voltage Regulator VF : LCD Supply Voltage Converter (1 = ON, 0 = OFF)	
17	Regulator Resistor Select	0	1	0	0	0	1	0	0	Ratio			Set the built-in resistor ratio (Rb/Ra)	
18	Electronic volume mode set	0	1	0	1	0	0	0	0	0	0	1	Set reference voltage mode	
	Electronic volume register set	0	1	0	*	*	Electronic Control value					Set reference voltage register		
19	Power Save		-	-	-	-	-	-	-	-	-	-	Compound instruction Display OFF + Entire Display ON	
20	NOP	0	1	0	1	1	1	0	0	0	1	1	Non-operation command	

12. Inspection Standards/检验标准

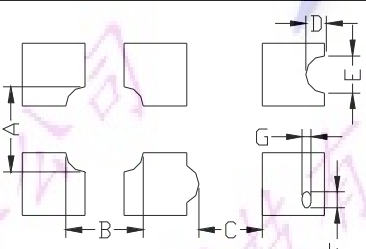
Item	Criterion for defects	Defect type
1) Display on inspection/显示效果	(1) Non display (2) Vertical line is deficient (3) Horizontal line is deficient (4) Cross line is deficient	Major
2) Black / White spot/黑点或白点	Size Φ (mm) Acceptable number $\Phi \leq 0.3$ Ignore (note) $0.3 < \Phi \leq 0.45$ 3 $0.45 < \Phi \leq 0.6$ 1 $0.6 < \Phi$ 0	Minor
3) Black / White line/黑线或白线	Length (mm) Width (mm) Acceptable number $L \leq 10$ $W \leq 0.03$ Ignore $5.0 \leq L \leq 10$ $0.03 < W \leq 0.04$ 3 $5.0 \leq L \leq 10$ $0.04 < W \leq 0.05$ 2 $1.0 \leq L \leq 10$ $0.05 < W \leq 0.06$ 2 $1.0 \leq L \leq 10$ $0.06 < W \leq 0.08$ 1 $L \leq 10$ $0.08 < W$ follows 2) point defect Defects separate with each other at an interval of more than 20mm	Minor
4) Display pattern/显示模式	 $\frac{A+B \leq 0.28}{2}$ $0 < C$ $\frac{D+E \leq 0.25}{2}$ $\frac{F+G \leq 0.25}{2}$ Note: 1) Up to 3 damages acceptable 2) Not allowed if there are two or more pinholes every three-fourth inch.	Minor
5) Spot-like contrast irregularity/均匀度	Size Φ (mm) Acceptable Number $\Phi \leq 0.7$ Ignore (note) $0.7 < \Phi \leq 1.0$ 3 $1.0 < \Phi \leq 1.5$ 1 $1.5 < \Phi$ 0 Note: 1) Conformed to limit samples. 2) Intervals of defects are more than 30mm.	Minor
6) Bubbles in polarizer/玻璃内有气泡	Size Φ (mm) Acceptable Number $\Phi \leq 0.4$ Ignore (note) $0.4 < \Phi \leq 0.65$ 2 $0.65 < \Phi \leq 1.2$ 1 $1.2 < \Phi$ 0	Minor
7) Scratches and dent on the polarizer/玻璃刮痕/凹痕	Scratches and dent on the polarizer shall be in the accordance with "2) Black/white spot", and "3) Black/White line".	Minor
8) Stains on the surface of LCD panel/玻璃上有污点	Stains which cannot be removed even when wiped lightly with a soft cloth or similar cleaning.	Minor
9) Rainbow color/杂色	No rainbow color is allowed in the optimum contrast on state within the active area.	Minor
10) Viewing-area encroachment/玻璃边线出现在视域	Polarizer edge or line is visible in the opening viewing area due to polarizer shortness or sealing line.	Minor
11) Bezel appearance/铁筐外观	Rust and deep damages that are visible in the bezel are rejected.	Minor
12) Defect of land surface 表面缺陷	Evident crevices that are visible are rejected.	Minor
13) Parts mounting/部件安装	(1) Failure to mount parts (2) Parts not in the specifications are mounted (3) For example: Polarity is reversed, HSC or TCP falls off.	Minor
14) Part alignment/部件结合度	(1) LSI, IC lead width is more than 50% beyond pad outline. (2) More than 50% of LSI, IC leads is off the pad outline.	Minor
15) Conductive foreign matter (solder ball, solder hips)/杂质 (焊接遗留物)	(1) $0.45 < \Phi$, $N \geq 1$ (2) $0.3 < \Phi \leq 0.45$, $N \geq 1$, Φ : Average diameter of solder ball (unit: mm) (3) $0.5 < L$, $N \geq 1$, L: Average length of solder chip (unit: mm)	Minor
16) Bezel flaw/铁筐缺裂	Bezel claw missing or not bent	Minor
17) Indication on name plate (sampling indication label)/标志	(1) Failure to stamp or label error, or not legible.(all acceptable if legible) (2) The separation is more than 1/3 for indication discoloration, in which the characters can be checked.	Minor

12. Handling precautions 注意事项

1. Refrain from strong mechanical shock and forces to the module. It may cause improper operating or damage to the module.
防止震动和压迫模组，以免造成模组损坏和运行正常。
2. The polarizer used on the display surface is easily scratched and damaged. Extreme care should be taken when handling. When cleaning the display surface, use soft cloth with a solvent recommended : ethyl alcohol , isopropyl or hexane) and wipe gently, do not use the following solvents : water, ketone or aromatics .
模组表面的偏光极易被刮伤和损坏，所以操作是要非常小心。请用蘸有乙醇，丙酮等溶剂的湿软布轻轻擦拭，不要使用水，乙酮等溶剂。
3. Wipe off water or oil drop immediately If you leave drop for a long time, stain and discoloration may occur.
要立即擦拭掉屏幕上的油滴和水滴，否则会出现污点和杂质。
4. Do not touch pads or pins of interface directly with bare hands. When handling the LCD module, put on a soft glover like finger-glover.
不要直接用手去触碰接口处的金属管脚。当操作模组的时候，请配带软指套。
5. Protect the module from static electricity, it may cause damage to CMOS LSI.
模组需要有防静电保护，否则会损坏CMOS LSI。
6. To prevent LCD panels from degradation, do not operate or store them exposed directly to sunlight or high temperature/humidity.
不要直接在太阳,高温或潮湿环境下操作和储存LCD模组，以免影响模组的质量。
7. If the liquid crystal leaks from the panel it should be kept away from the eyes and mouths. In case of contact with skins, wash away thoroughly with soap and water.
若有液晶漏出，务必避免其入眼入口。若沾到皮肤上了，马上用肥皂和水冲洗干净。
8. Soldering should be only performed on the I/O terminals within the temperature of $280 \pm 20^{\circ}\text{C}$ and soldering time should be less than 4 seconds.
要在 $280 \pm 20^{\circ}\text{C}$ 的条件下在I/O终端实现焊接，并且保证焊接时间短于4秒。
9. Supply voltage within the specified voltage limit, the maximum rating, higher voltage cause the shorter LCD life or damaged.
绝对要在指定的电压范围内驱动模组，因为如果在高于指定电压的情况下驱动模组，会使模组寿命变短
10. Do not input any signals before power is turned on. Do not connect or disconnect the module on the state of Power-ON.
供电之前不要输入任何信号，不要在通电时连接和段开 LCD 模组。