

## Approval sheet

**Customer:** \_\_\_\_\_  
**Modelname:** COG-TM700KFY-01P  
**Spec NO:** \_\_\_\_\_  
**Date:** 2014.11.22  
**Version:** 02

- Preliminary Specification**  
 **Final Specification**

### For Customer's Acceptance

Approved by	Content

Approved by	Reviewed by	Prepared by

## Record of Reversion

Version	Revise date	Page	Content
01	2014.3.28		First issue
02	2014.11.22	22	Modify the drawing



深圳市科飞研科技有限公司

深圳市科飞研科技有限公司

## Contents

1. General Specifications.....	4
2. Pin Assignment .....	5
3. Operation Specifications.....	8
3.1. Absolute Maximum Rating.....	8
3.1.1. Typical Operation Conditions.....	8
3.1.2. Current Consumption .....	9
3.1.3. Backlight Driving Conditions.....	9
3.2. Power Sequence .....	10
3.3. Timing Characteristics .....	11
3.3.1. AC Electrical Characteristics .....	11
3.3.2. Data Input Format.....	12
3.3.3. Timing.....	13
4. Touch Screen Panel Specifications.....	15
4.1. Electrical Characteristics .....	15
4.2. Mechanical & Reliability Characteristics .....	15
4.3. Linearity Definition .....	16
4.4. Housing Design Guide.....	18
5. Optical Specifications.....	19
6. Reliability Test Items.....	23
7. General Precautions.....	24
7.1. Safety .....	24
7.2. Handling .....	24
7.3. Static Electricity .....	24
7.4. Storage .....	24
7.5. Cleaning .....	24
8. Mechanical Drawing .....	25
9. Package Drawing .....	26
9.1 Packaging Material Table.....	26
9.2 Packaging Quantity .....	26
9.3 Packaging Drawing.....	26

## 1. General Specification

No.	Item	Specification	Remark
1	LCD size	7.0 inch(Diagonal)	
2	Driver element	a-Si TFT active matrix	
3	Resolution	800 × 3(RGB) × 480	
4	Display mode	Normally White, Transmissive	
5	Dot pitch	0.1926(W) × 0.1790(H) mm	
6	Active area	154.08(W) × 85.92(H) mm	
7	Module size	164.9(W) × 100(H) × 7.0(D) mm	Note 1
8	Surface treatment	Anti-Glare	
9	Color arrangement	RGB-stripe	
11	Interface	24Bit RGB (TTL)	
12	Backlight power consumption	1.512W	
13	Optimum viewing direction	6 O'CLOCK	
14	Weight	TBD	

Note 1: Refer to Mechanical Drawing.

## 2. Pin Assignment

### TFT LCD Panel Driving Section

FPC Connector is used for the module electronics interface. The recommended model is FH12A-50S-0.5SH manufactured by Hirose.

Pin No.	Symbol	I/O	Function	Remark
1	V <sub>LED+</sub>	P	Power for LED backlight (Anode)	
2	V <sub>LED+</sub>	P	Power for LED backlight (Anode)	
3	V <sub>LED-</sub>	P	Power for LED backlight (Cathode)	
4	V <sub>LED-</sub>	P	Power for LED backlight (Cathode)	
5	GND	P	Power ground	
6	V <sub>COM</sub>	I	Common voltage	
7	DV <sub>DD</sub>	P	Power for Digital Circuit	
8	MODE	I	DE/SYNC mode select	Note 1
9	DE	I	Data Input Enable	
10	VS	I	Vertical Sync Input	
11	HS	I	Horizontal Sync Input	
12	B7	I	Blue data(MSB)	
13	B6	I	Blue data	
14	B5	I	Blue data	
15	B4	I	Blue data	
16	B3	I	Blue data	
17	B2	I	Blue data	
18	B1	I	Blue data	Note 2
19	B0	I	Blue data(LSB)	Note 2
20	G7	I	Green data(MSB)	
21	G6	I	Green data	
22	G5	I	Green data	
23	G4	I	Green data	
24	G3	I	Green data	
25	G2	I	Green data	
26	G1	I	Green data	Note 2

27	G0	I	Green data(LSB)	Note 2
28	R7	I	Red data(MSB)	
29	R6	I	Red data	
30	R5	I	Red data	
31	R4	I	Red data	
32	R3	I	Red data	
33	R2	I	Red data	
34	R1	I	Red data	Note 2
35	R0	I	Red data(LSB)	Note 2
36	GND	P	Power Ground	
37	DCLK	I	Sample clock	Note 3
38	GND	P	Power Ground	
39	L/R	I	Left / right selection	Note 4,5
40	U/D	I	Up/down selection	Note 4,5
41	VGH	P	Gate ON Voltage	
42	VGL	P	Gate OFF Voltage	
43	AVDD	P	Power for Analog Circuit	
44	RESET	I	Global reset pin.	Note 6
45	NC	-	No connection	
46	VCOM	I	Common Voltage	
47	DITHB	I	Dithering function	Note 7
48	GND	P	Power Ground	
49	NC	-	No connection	
50	NC	-	No connection	

I: input, O: output, P: Power

Note 1: DE/SYNC mode select. Normally pull high.

When select DE mode, MODE="1", VS and HS must pull high.

When select SYNC mode, MODE="0", DE must be grounded.

Note 2: When input 18 bits RGB data, the two low bits of R,G and B data must be grounded.

Note 3: Data shall be latched at the falling edge of DCLK.

Note 4: Selection of scanning mode.

Set of scan control input		Scanning direction
U/D	L/R	
GND	DVDD	Up to down, left to right
DVDD	GND	Down to up, right to left
GND	GND	Up to down, right to left
DVDD	DVDD	Down to up, left to right

Note 5: Definition of scanning direction.

Refer to the figure as below:

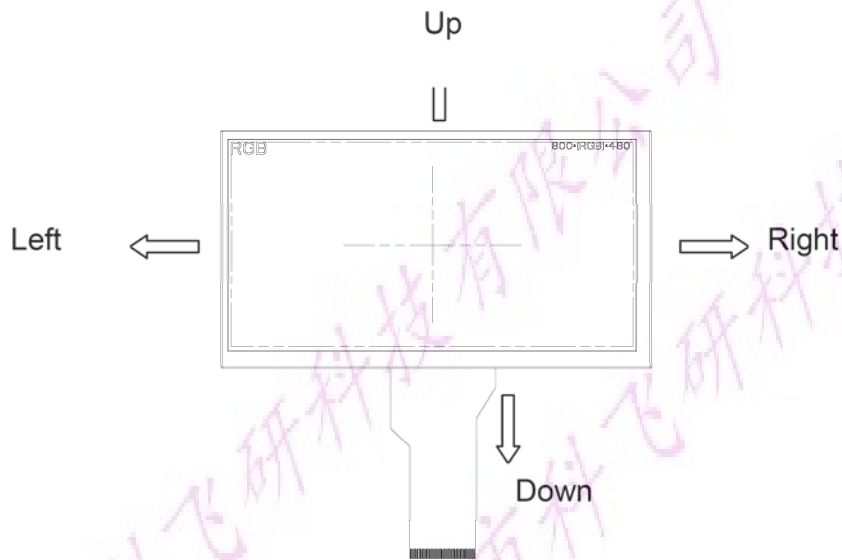

Note 6: Global reset pin. Active low to enter reset state. Suggest to connect with an RC reset circuit for stability. Normally pull high.

Note 7: Dithering function enable control, normally pull high.

When DITHB="1", Disable internal dithering function,

When DITHB="0", Enable internal dithering function.

## 2.2. Touch Screen Panel Section

Pin No.	Symbol	I/O	Function	Remark
1	Y+	Top	Top electrode – differential analog	
2	X-	Left	Left electrode – differential analog	
3	Y-	Bottom	Bottom electrode – differential analog	
4	X+	Right	Right electrode – differential analog	

Note: Touch screen panel block

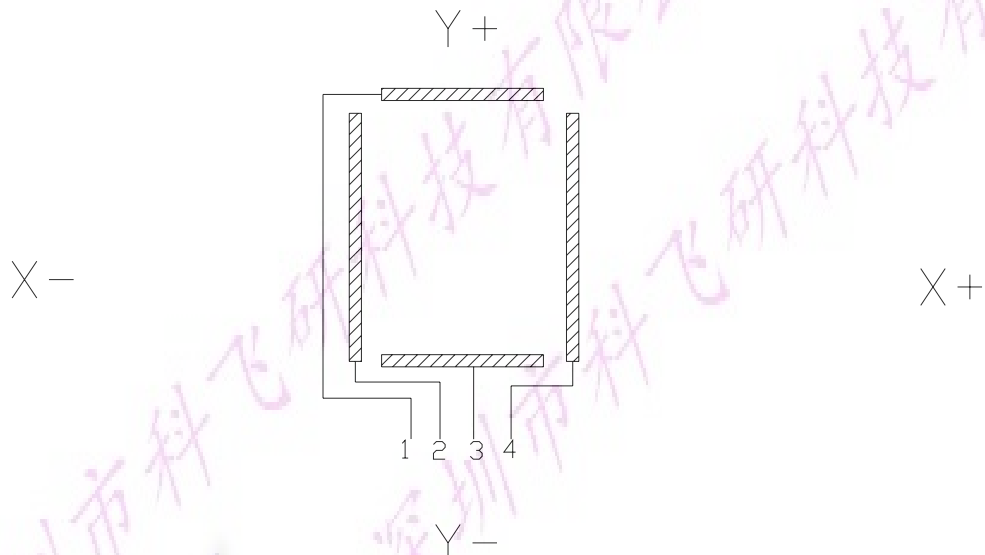



### 3. Operation Specifications

#### 3.1. Absolute Maximum Ratings (Note 1)

Item	Symbol	Values		Unit	Remark
		Min.	Max.		
Power voltage	DVDD	-0.3	5.0	V	
	AVDD	6.5	13.5	V	
	VGH	-0.3	40.0	V	
	VGL	-20.0	0.3	V	
	VGH-VGL	-	40.0	V	
Operation Temperature	TOP	-20	70	°C	
Storage Temperature	TST	-30	80	°C	
LED Reverse Voltage	VR	-	1.2	V	Each LED, Note 2
LED Forward Current	IF	-	25	mA	Each LED

Note 1: The absolute maximum rating values of this product are not allowed to be exceeded at any times. Should a module be used with any of the absolute maximum ratings exceeded, the characteristics of the module may not be recovered, or in an extreme case, the module may be permanently destroyed.

Note 2: VR Conditions: Zener Diode 20mA

#### 3.1.1. Typical Operation Conditions (NOTE1)

Item	Symbol	Values			Unit	Remark
		Min.	Typ.	Max.		
Power voltage	DVDD	3.0	3.3	3.6	V	Note 2
	AVDD	10.2	10.4	10.6	V	
	VGH	15.3	16.0	16.7	V	
	VGL	-7.7	-7.0	-6.3	V	
Input signal voltage	VCOM	2.6	3.6	4.6	V	
Input logic high voltage	VIH	0.7 DVDD	-	DVDD	V	Note 3
Input logic low voltage	VIL	0	-	0.3 DVDD	V	

Note 1: Be sure to apply DV<sub>DD</sub> and V<sub>GL</sub> to the LCD first, and then apply V<sub>GH</sub>.

Note 2: DV<sub>DD</sub> setting should match the signals output voltage (refer to Note 3) of Customer's system board.

Note 3: DCLK,HS,VS,RESET,U/D, L/R,DE,R0~R7,G0~G7,B0~B7,MODE,DITHB.

### 3.1.2. Current Consumption (Note3)

Item	Symbol	Values			Unit	Remark
		Min.	Typ.	Max.		
Current for Driver	I <sub>GH</sub>	-	TBD		mA	
	I <sub>GL</sub>	-	TBD		mA	
	ID <sub>VDD</sub>	-	TBD		mA	
	IA <sub>VDD</sub>	-	TBD		mA	

### 3.1.3. Backlight Driving Conditions

Item	Symbol	Values			Unit	Remark
		Min.	Typ.	Max.		
Voltage for LED backlight	V <sub>L</sub>	-	10.8	-	V	Note 1
Current for LED backlight	I <sub>L</sub>	-	140	-	mA	
LED life time	-	20,000	-	-	Hr	Note 2

Note 1: The LED Supply Voltage is defined by the number of LED at Ta=25°C and

$$I_L = 140\text{mA}.$$

Note 2: The “LED life time” is defined as the module brightness decrease to 50% original brightness at Ta=25°C and I<sub>L</sub> =140mA. The LED lifetime could be decreased if operating I<sub>L</sub> is larger than 140 mA.

Note 3:Typ.specification:Gray-level test pattern; Max.specification:Black-level test pattern.

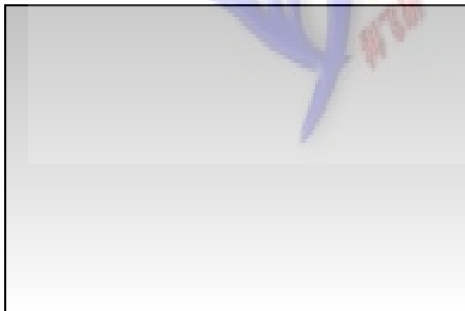

(a) Gray-level test pattern



(b) Black-level test pattern

## 3.2. Power Sequence

a. Power on:

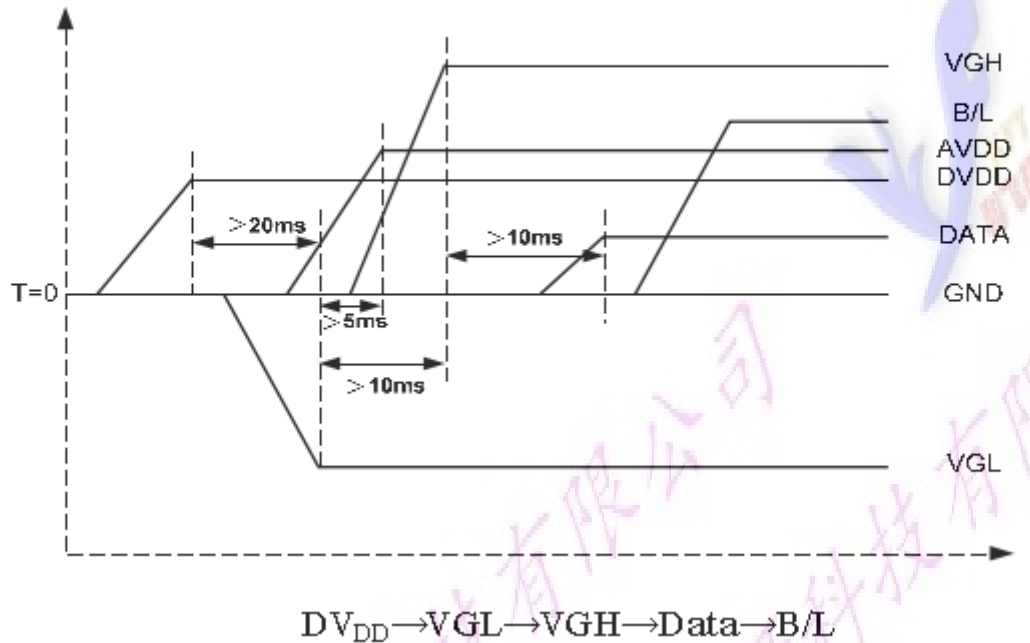

b. Power off:

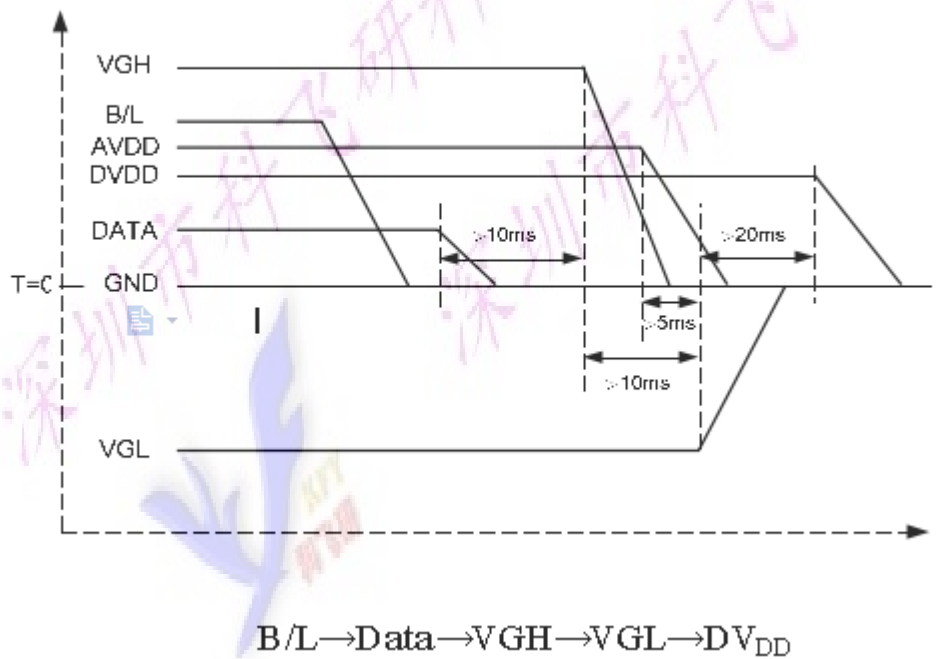

Note: Data include R0~R7, B0~B7, GO~G7, U/D, L/R, DCLK, HS, VS, DE.

### 3.3. Timing Characteristics

#### 3.3.1. AC Electrical Characteristics

Item	Symbol	Values			Unit	Remark
		Min.	Typ.	Max.		
HS setup time	Thst	8	-	-	ns	
HS hold time	Thh	8	-	-	ns	
VS setup time	Tvst	8	-	-	ns	
VS hold time	Tvh	8	-	-	ns	
Data setup time	Tds	8	-	-	ns	
Data hole time	Tdh	8	-	-	ns	
DE setup time	Tes	8	-	-	ns	
DE hole time	Teh	8	-	-	ns	
DVDD Power On Slew rate	TPOR	-	-	20	ms	From 0 to 90% DVDD
RESET pulse width	TRst	1	-	-	ms	
DCLK cycle time	Tco	20	-	-	ns	
DCLK pulse duty	Tcwh	40	50	60	%	

3.3.2. Data Input Format



Figure 3.1 Horizon input timing diagram

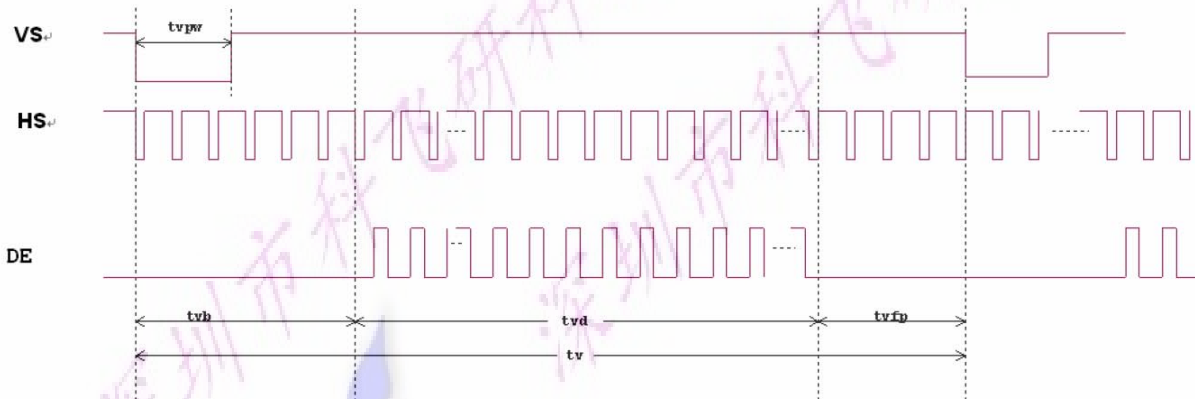

Figure 3.2 Vertical input timing diagram

## 3.3.3. Timing

Item	Symbol	Values			Unit	Remark
		Min.	Typ.	Max.		
Horizontal Display Area	thd	-	800	-	DCLK	
DCLK Frequency	fclk	29.0	33.0	38.0	MHz	
One Horizontal Line	th	1026	1056	1086	DCLK	
HS pulse width	thpw	-	30	-	DCLK	
HS Blanking	thb	-	16	-	DCLK	
HS Front Porch	thfp	180	210	240	DCLK	

Item	Symbol	Values			Unit	Remark
		Min.	Typ.	Max.		
Vertical Display Area	tvd	-	480	-	TH	
VS period time	tv	515	525	535	TH	
VS pulse width	tvpw	-	13	-	TH	
VS Blanking	tvb	-	10	-	TH	
VS Front Porch	tvfp	12	22	32	TH	

## 4. Touch Screen Panel Specifications

### 4.1. Electrical Characteristics

Item	Value			Unit	Remark
	Min.	Typ.	Max.		
Linearity	--	--	3.0	%	Analog X and Y directions
Terminal Resistance	440	-	1100	$\Omega$	X(Film side)
	100	-	420	$\Omega$	Y(Glass side)
Insulation resistance	25	-	-	M $\Omega$	DC 25V
Voltage	-	-	10	V	DC
Chattering	-	-	10	ms	100k $\Omega$ pull-up
Transparency	78	-	-	%	

Note: Avoid operating with hard or sharp material such as a ball point pen or a mechanical pencil except a polyacetal pen (tip R0.8mm or less) or a finger.

### 4.2. Mechanical & Reliability Characteristics

Item	Value			Unit	Remark
	Min.	Typ.	Max.		
Active force	20	-	100	gf	Note 1
Durability-surface scratching	Write 100,000	-	-	characters	Note 2
Durability-surface pitting	1,000,000	-	-	touches	Note 3
Surface hardness	3	-	-	H	

Note 1: Active force test condition

- (1) Input DC 5V on X direction, Drop off Polyacetal Stylus (R0.8), until output voltage stabilize, then get the activation force.
- (2) R8.0mm Silicon rubber for finger Activation force test
- (3) Test point: 9 points

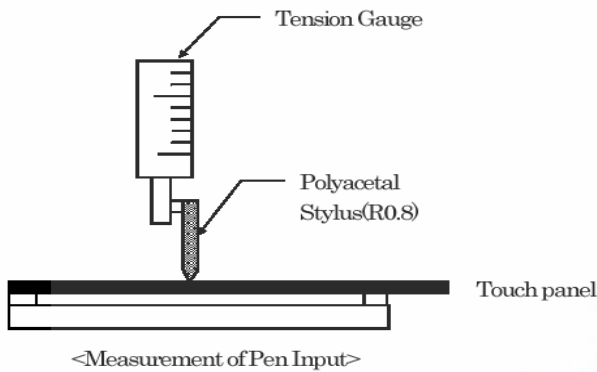

Note 2: Measurement for surface area.

- Scratch 100,000 times straight line on the film with a stylus change every 20,000 times.
- Force: 150gf.
- Speed: 60mm/sec.
- Stylus: R0.8 polyacetal tip.

Note 3: Pit 1,000,000 times on the film with a R0.8 silicon rubber.

- Force: 250gf.
- Speed: 2times/sec.

### 4.3. Linearity Definition

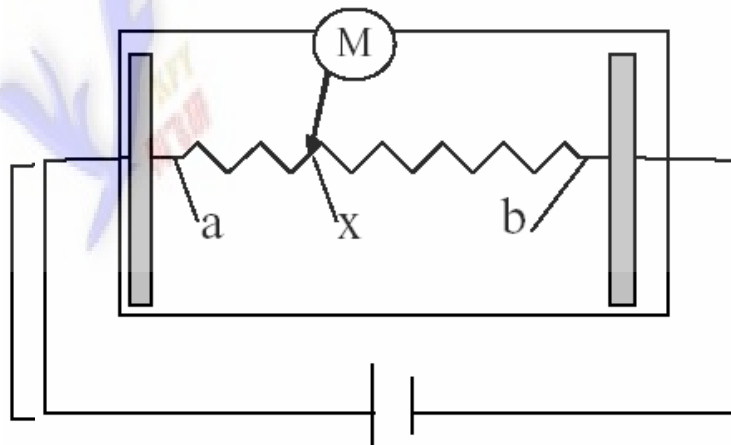

V<sub>a</sub>: maximum voltage in the active area of touch panel



Vb: minimum voltage in the active area of touch panel X: random measuring point

Vxm: actual voltage of Lx point

Vxi: theoretical voltage of Lx point

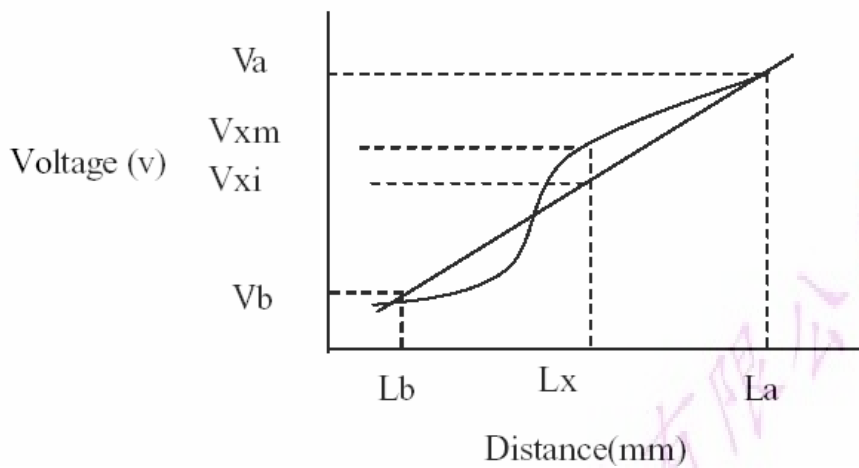

$$\text{Linearity} = \frac{|V_{xi} - V_{xm}|}{(V_a - V_b)} * 100\%$$

Note: Test area is as follows and operation force is 100gf

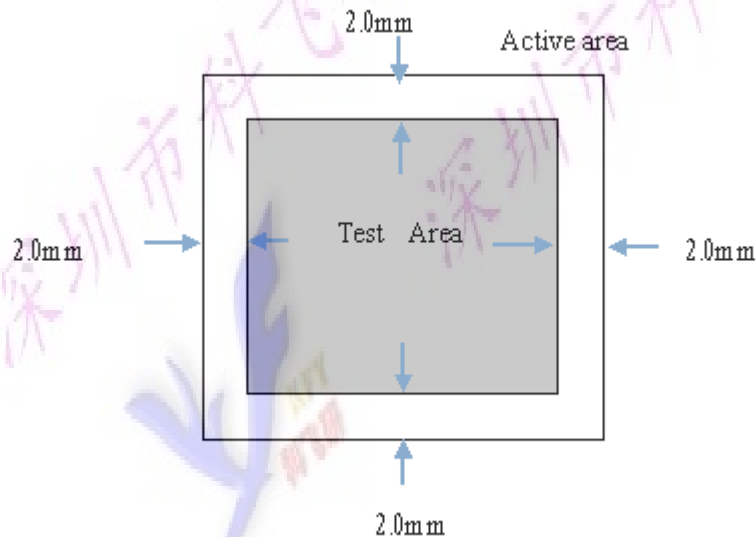

### 4.4. Housing Design Guide

Housing design follow as below.

- 1) Avoid the design that housing overlap and press on the active area of the LCM.
- 2) Give enough gap(over 0.5mm at compressed) between the housing and TSP to protect wrong operating.

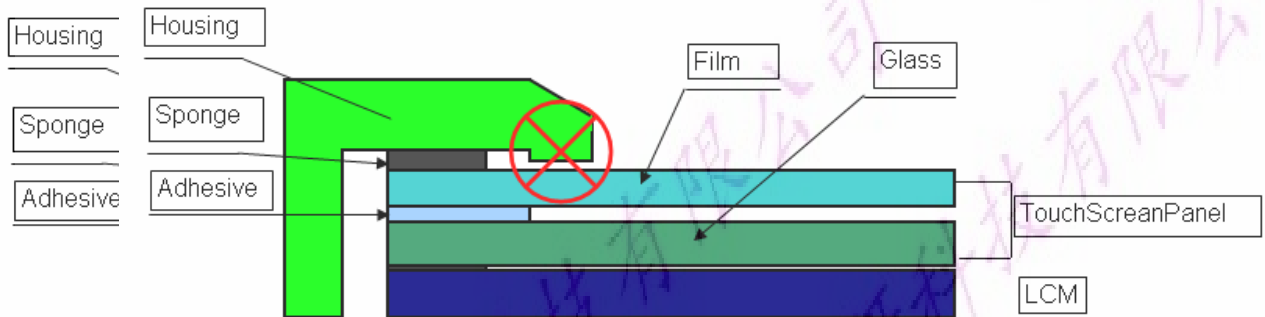

- 3) Use a buffer material(Gasket) between the TSP and housing to protect damage and wrong operating.area.overlap and press on the inside of TSP view

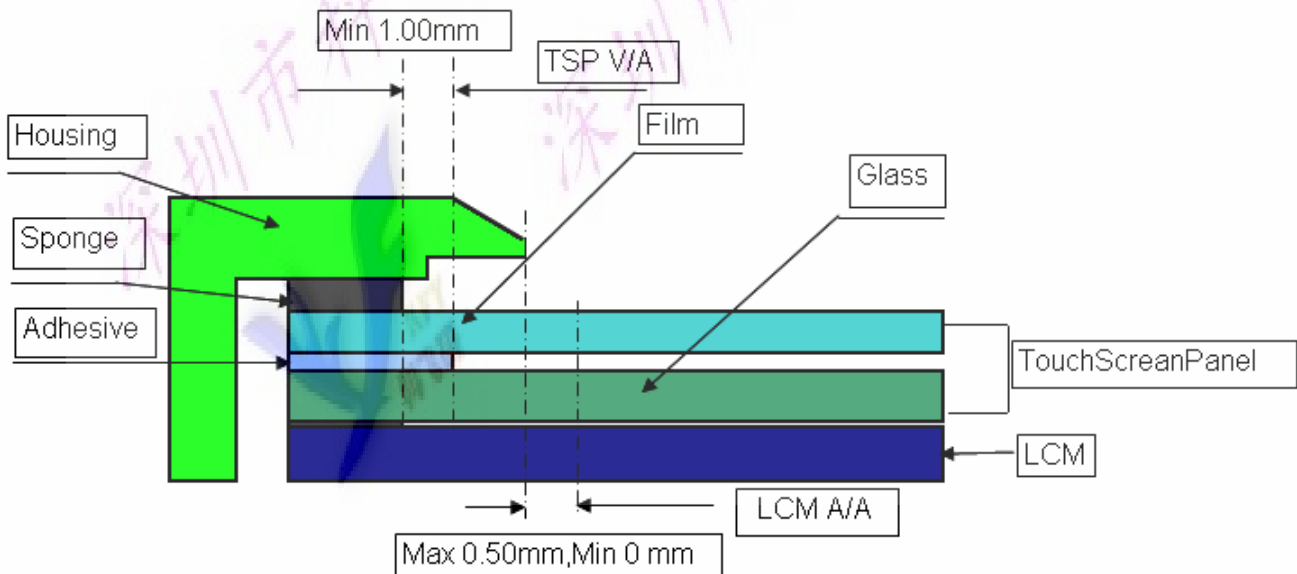

## 5. Optical Specifications

Item	Symbol	Condition	Values			Unit	Remark
			Min.	Typ.	Max.		
Viewing angle (CR $\geq$ 10)	$\theta_L$	$\Phi=180^\circ$ (9 o'clock)	60	70	-	degree	Note 1
	$\theta_R$	$\Phi=0^\circ$ (3 o'clock)	60	70	-		
	$\theta_T$	$\Phi=90^\circ$ (12 o'clock)	40	50	-		
	$\theta_B$	$\Phi=270^\circ$ (6 o'clock)	60	70	-		
Response time	T <sub>ON</sub>	Normal $\theta=\Phi=0^\circ$	-	10	20	msec	Note 3
	T <sub>OFF</sub>		-	15	30	msec	Note 3
Contrast ratio	CR		400	500	-	-	Note 4
	W <sub>X</sub>		0.250	0.300	0.350	-	
	W <sub>Y</sub>		0.290	0.340	0.390	-	
Luminance	L		300	340	370	cd/m <sup>2</sup>	Note 6
Luminance uniformity	YU		70	75	-	%	Note 7

### Test conditions:

1.  $DV_{DD}=3.6V$ ,  $I_L=140mA$  (Backlight current), the ambient temperature is  $25^\circ C$
2. The test systems refer to Note 2.

Note 1: Definition of viewing angle range

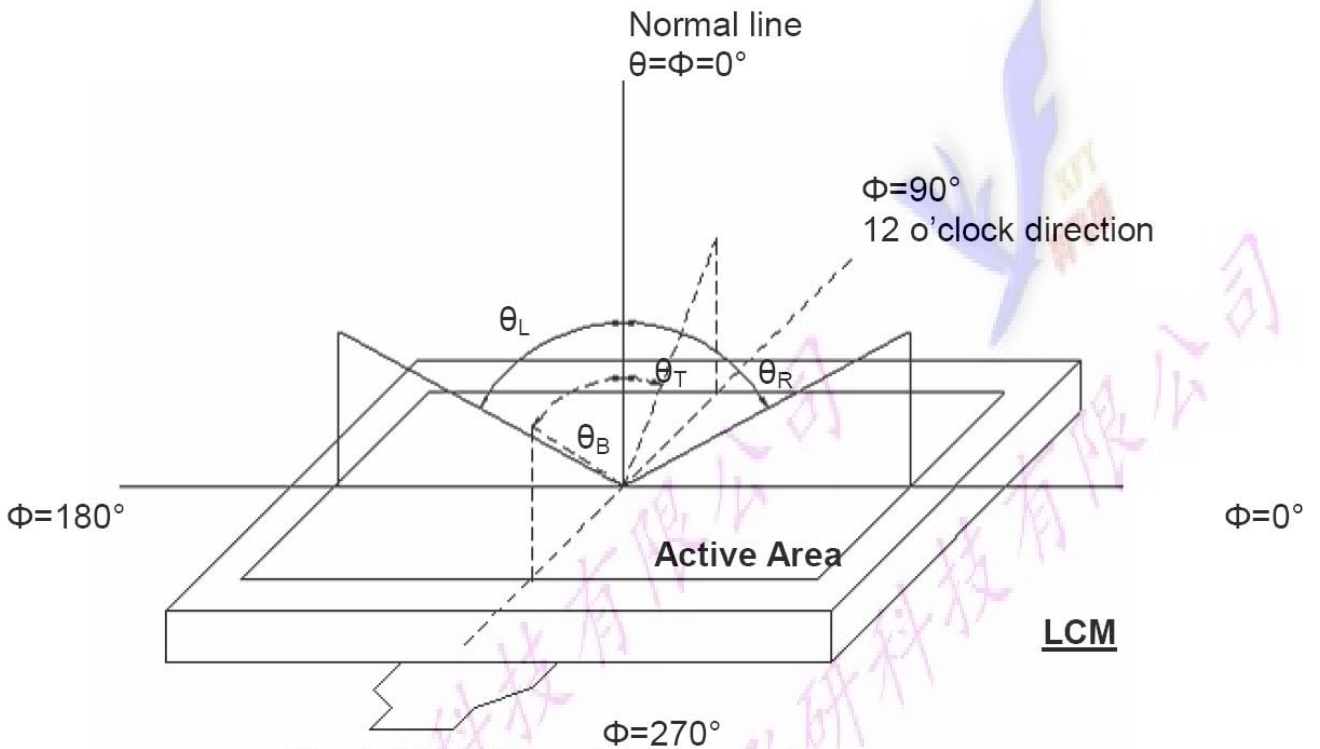

Fig. 4-1 Definition of viewing angle

Note 2: Definition of optical measurement system.

The optical characteristics should be measured in dark room. After 30 minutes operation, the optical properties are measured at the center point of the LCD screen. (Response time is measured by Photo detector TOPCON BM-7, other items are measured by BM-5A/Field of view:  $1^\circ$  /Height: 500mm.)

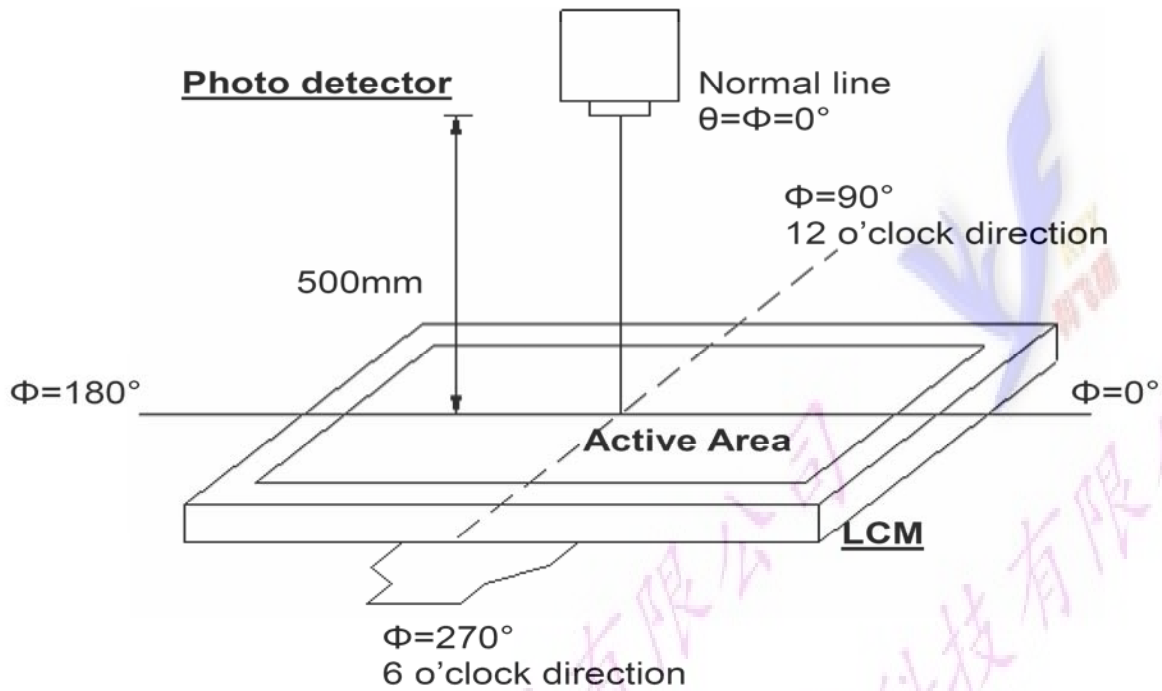

Figure 4-2 Optical measurement system setup

## Note 3: Definition of Response time

The response time is defined as the LCD optical switching time interval between “White” state and “Black” state. Rise time ( $T_{ON}$ ) is the time between photo detector output intensity changed from 90% to 10%. And fall time ( $T_{OFF}$ ) is the time between photo detector output intensity changed from 10% to 90%.

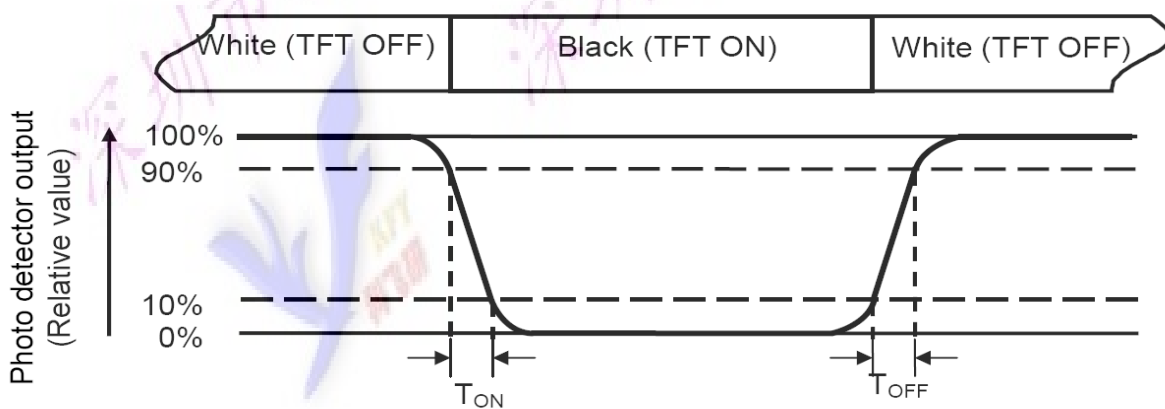

Figure 4-3 Definition of response time

## Note 4: Definition of contrast ratio

$$\text{Contrast ratio (CR)} = \frac{\text{state White"} \text{ the on LCD when measured Luminance}}{\text{Luminance measured when LCD on the "Black" state}}$$

Note 5: Definition of color chromaticity (CIE1931)

Color coordinates measured at center point of LCD.

Note 6: All input terminals LCD panel must be ground while measuring the center area of the panel. The LED driving condition is  $I_L=180\text{mA}$ .

Note 7: Definition of Luminance Uniformity

Active area is divided into 9 measuring areas (Refer to Fig. 4-4).

Every measuring point is placed at the center of each measuring area.

$$\text{Luminance Uniformity (YU)} = \frac{B_{\min}}{B_{\max}}$$

L=Active area length    W=Active area width

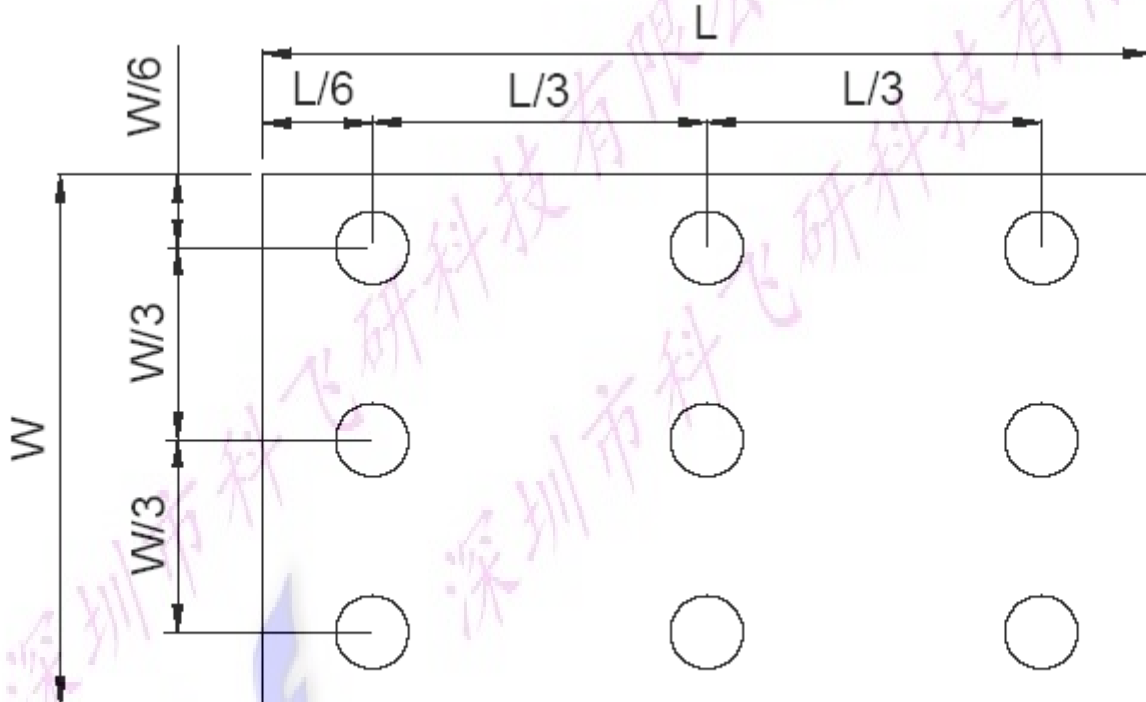

Fig. 4-4 Definition of measuring points

$B_{\max}$ : The measured maximum luminance of all measurement position.

$B_{\min}$ : The measured minimum luminance of all measurement position.

**6. Reliability Test Items**

(NOTE 3)

Item	Test Conditions	Remark
High temperature storage	Ta=80℃ 240hrs	NOTE1 , NOTE4
Low temperature storage	Ta=-30℃ 240hrs	NOTE1 , NOTE4
High temperature operation	Ta=70℃ 240hrs	NOTE2 , NOTE4
Low temperature operation	Ta=-20℃ 240hrs	NOTE2 , NOTE4
Operate at high temperature and humidity	+60℃, 90%RH 240hrs	NOTE4
Thermal Shock	-30℃/30min~+80℃/30min for a total 100 cycles ,start with cold temperature and end with high temperature .	NOTE4
Vibration Test	Frequency range:10~55HZ Stroke:1.5mm Swap:10HZ~55HZ~10HZ 2 hours of each direction of X.Y. Z (6 hours for total)	
Mechanical shock	100G 6ms, ± X, ± Y, ± Z 3 times for each direction	
Package vibration test	Random vibration :0.15G*G/HZ from 5-200 HZ,-6dB/Octave from 200-500HZ of each direction of X.Y. Z (6 hours for total)	
Low temperature storage	Height:60cm 1 corner ,3 edges ,6 surfaces	
Low temperature storage	± 2KV ,Human Body Mode, 100pF/1500 Ω	

Note 1: Ta is the ambient temperature of samples.

Note 2: Ts is the temperature of panel's surface.

Note 3: In the standard condition, there shall be no practical problem that may affect the display function. After the reliability test, the product only guarantees operation, but don't guarantee all of the cosmetic specification.

Note 4: Before cosmetic and function test, the product must have enough recovery time,at least 2 hours at room temperature.

## 7. General Precautions

### 7.1. Safety

Liquid crystal is poisonous. Do not put it in your mouth. If liquid crystal touches your skin or clothes, wash it off immediately by using soap and water.

### 7.2. Handling

1. The LCD panel is plate glass. Do not subject the panel to mechanical shock or to excessive force on its surface.

2. The polarizer attached to the display is easily damaged. Please handle it carefully to avoid scratch or other damages.

3. To avoid contamination on the display surface, do not touch the module surface with bare hands.

4. Keep a space so that the LCD panels do not touch other components.

5. Put cover board such as acrylic board on the surface of LCD panel to protect panel from damages.

6. Transparent electrodes may be disconnected if you use the LCD panel under environmental conditions where the condensation of dew occurs.

7. Do not leave module in direct sunlight to avoid malfunction of the ICs.

### 7.3. Static Electricity

1. Be sure to ground module before turning on power or operating module.

2. Do not apply voltage which exceeds the absolute maximum rating value.

### 7.4. Storage

1. Store the module in a dark room where must keep at  $25\pm 10^{\circ}\text{C}$  and 65%RH or less.

2. Do not store the module in surroundings containing organic solvent or corrosive gas.

3. Store the module in an anti-electrostatic container or bag.

### 7.5. Cleaning

1. Do not wipe the polarizer with dry cloth. It might cause scratch.

2. Only use a soft cloth with IPA to wipe the polarizer, other chemicals might permanent damage to the polarizer.





## 9. Package Drawing

### 9.1. Packaging Material Table

No.	Item	Model (Material)	Dimensions(mm)	Unit Weight (kg)	Quantity	Remark
1	LCM Module	COG-T700MIWN-01	164.9x100x7.0	---	60	
2	Partition	BC Corrugated paper	512x349x226	1.466	1set	
3	Corrugated Paper	B Corrugated paper	510x350	0.071	4pcs	
4	Corrugated Bar	B Corrugated paper	512x11x3	0.046	4pcs	
5	Dust-Proof Bag	PE	700 × 530	0.048	1pcs	
6	A/S Bag	PE	180 × 133 × 0.2	0.002	30pcs	
7	Carton	Corrugated paper	530 × 355 × 255	1.100	1 pcs	
8	Total weight	TBD				

### 9.2. Packaging Quantity

Total LCM quantity in Carton: no. Of Partition  
 $2 \text{ Rows} \times \text{quantity per Row } 30 = 60$

### 9.3. Packaging drawing

TBD